



**Changzhou Inter Camp Outdoor
Appliance Technology Co.,Ltd**

EAT-CAMP2.0

OUTDOOR CAMPING KITCHEN

WE CAN TAKE IT JUST LIKE TRAVELING CASE TO GO ANYWHERE

RV TOURING OR GARDEN BARBECUE PARTY

WILD EXPLORATION

OUTDOOR CAMPING





01

Changzhou Intercamp Outdoor Appliance Technology Co., Ltd which focuses on the design, development and production of outdoor integrated products. With utility innovation as our principal route, we center on green environmental protection, new material application, and fashionable novelty as the carrier to design outdoor camping and leisure products. Not only exports the product to America, European and Australia market. And also we provide two-way services to domestic outdoor and camping market purchasing agent.

Since 2017, the original outdoor integrated kitchen box we produced had been sold well AMAZON international site and achieved high praise from customers. Now the upgraded version of cooking station named EAT-CAMP 2.0 has also been launched.

Here we sincerely invite friends to visit, investigate and cooperate with us to create bright future.

DEVELOPMENT HISTORY



2007

Establishment

Founded in 2007, mainly engaged in the import and export business of products. Business scope cover more than 150 countries and regions.



2015

Reform

In 2015, We reconstituted and established Changzhou Intecamp Outdoor Appliances Technology Co., Ltd which officially entered the field of outdoor products.



2017

EC Original

In order to meet the needs of consumers, a new and exclusive patent design of outdoor portable kitchen box was officially designed and produced in November 2017, and is defined as Eat-camp original.



2021

Eat-Camp 2.0

As living standards and the concept of consumption, further upgrades the products to meet people's requirements. It's EAT-CAMP 2.0.



Usage Scenario



PRODUCT MODELS

Normal Standard Size

01

EC 2.0-G GAS STOVE MODEL

02

**EC 2.0-E INDUCTION COOKER
MODEL**

03

EC 2.0-B IGT BBQ GRILL MODEL

04

EC 2.0-T TABLE MODEL

Normal Standard Size: EC 2.0-G GAS STOVE MODEL

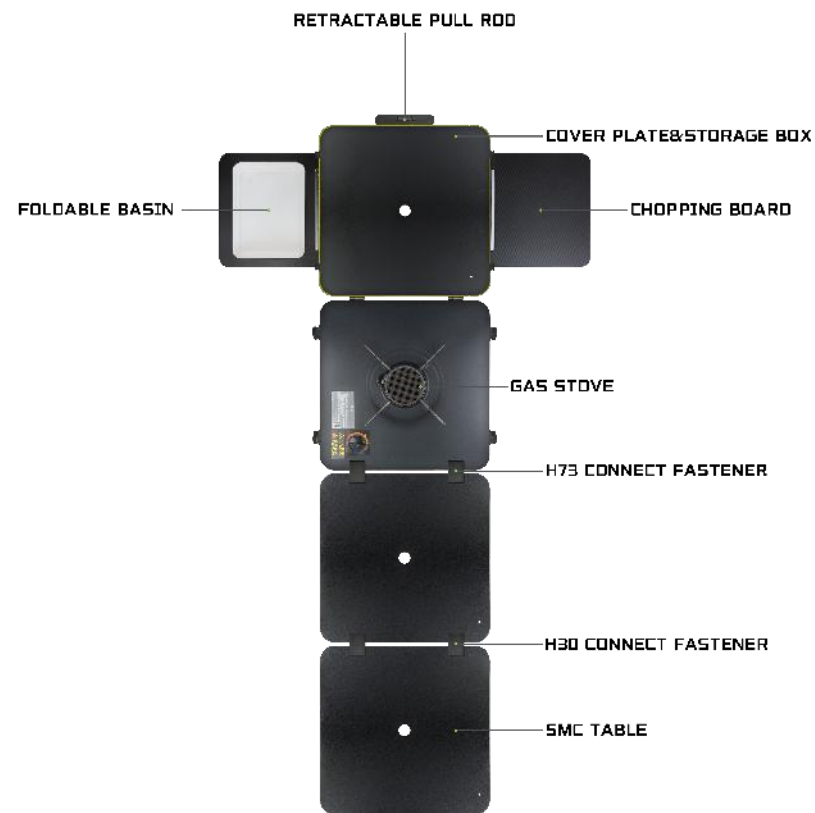
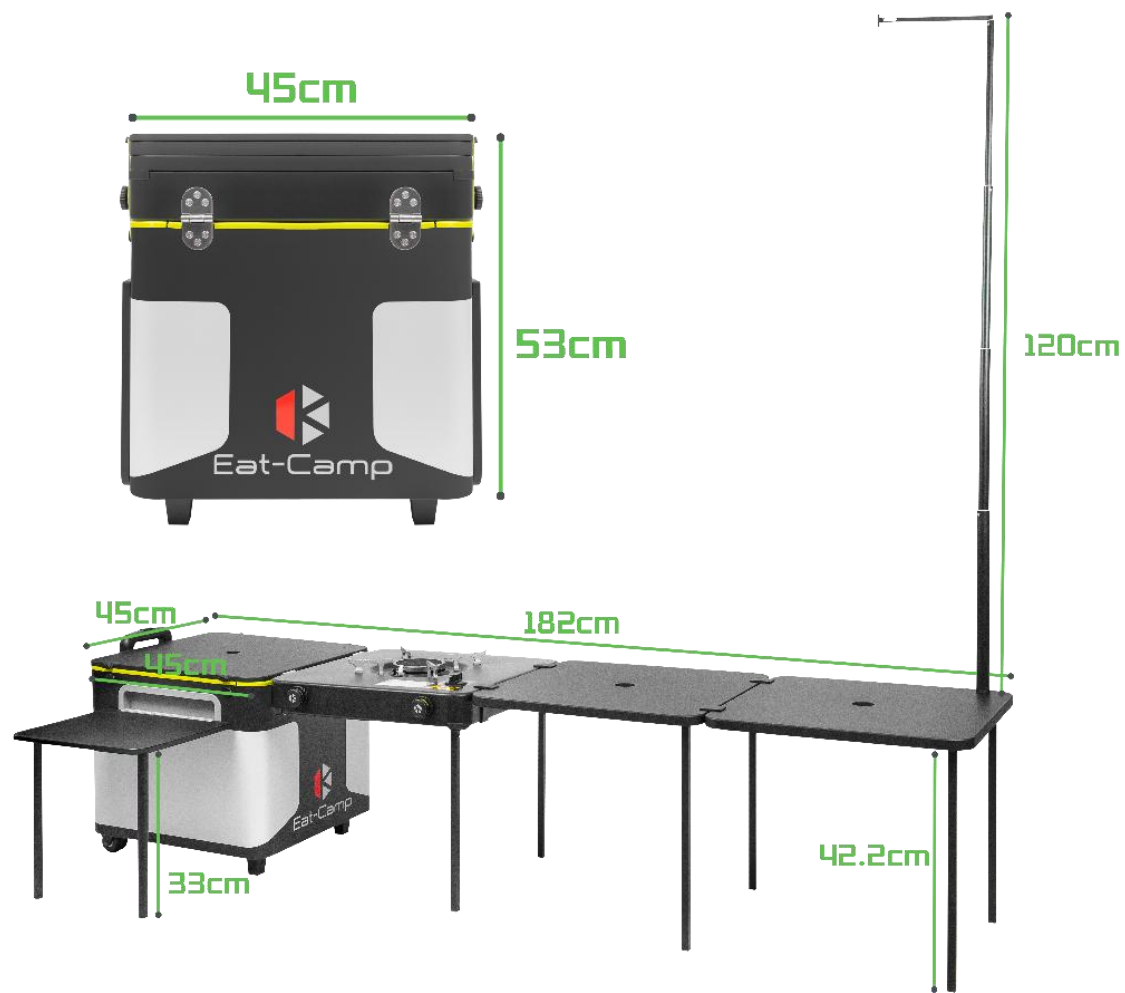

Normal Standard Size : EC 2.0-E INDUCTION COOKER MODEL

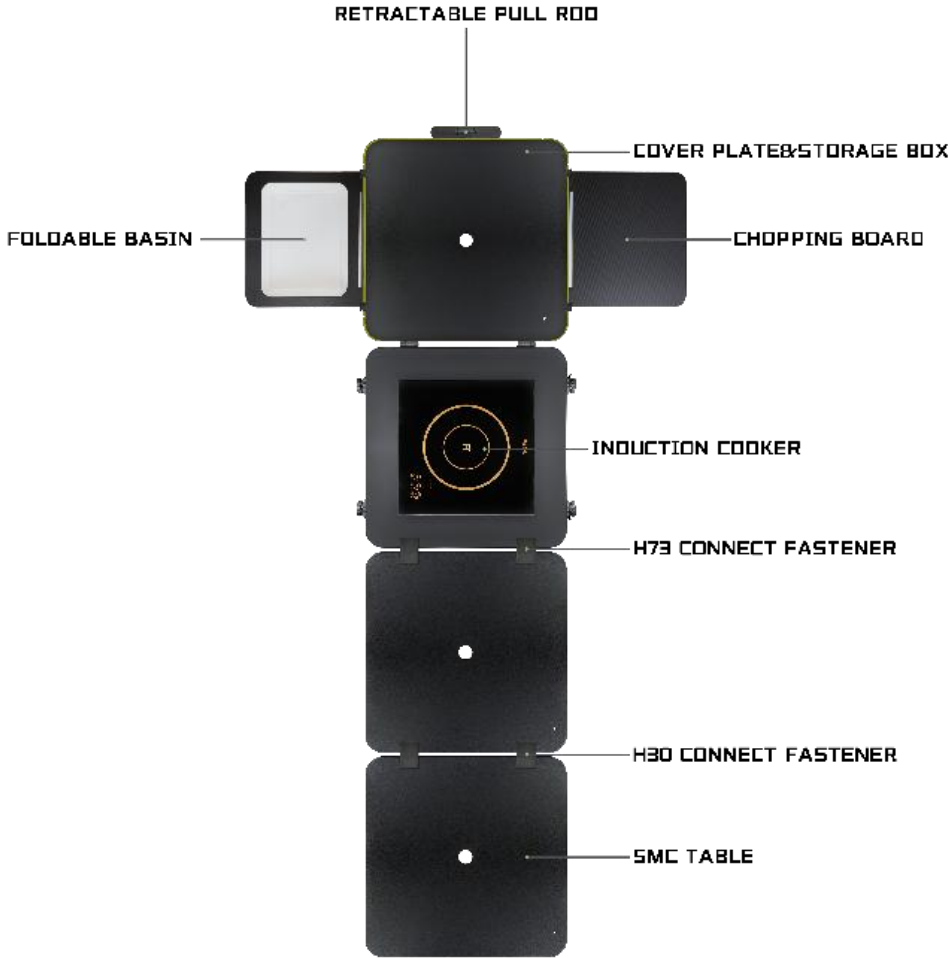

Normal Standard Size: EC 2.0-B BBQ GRILL MODEL

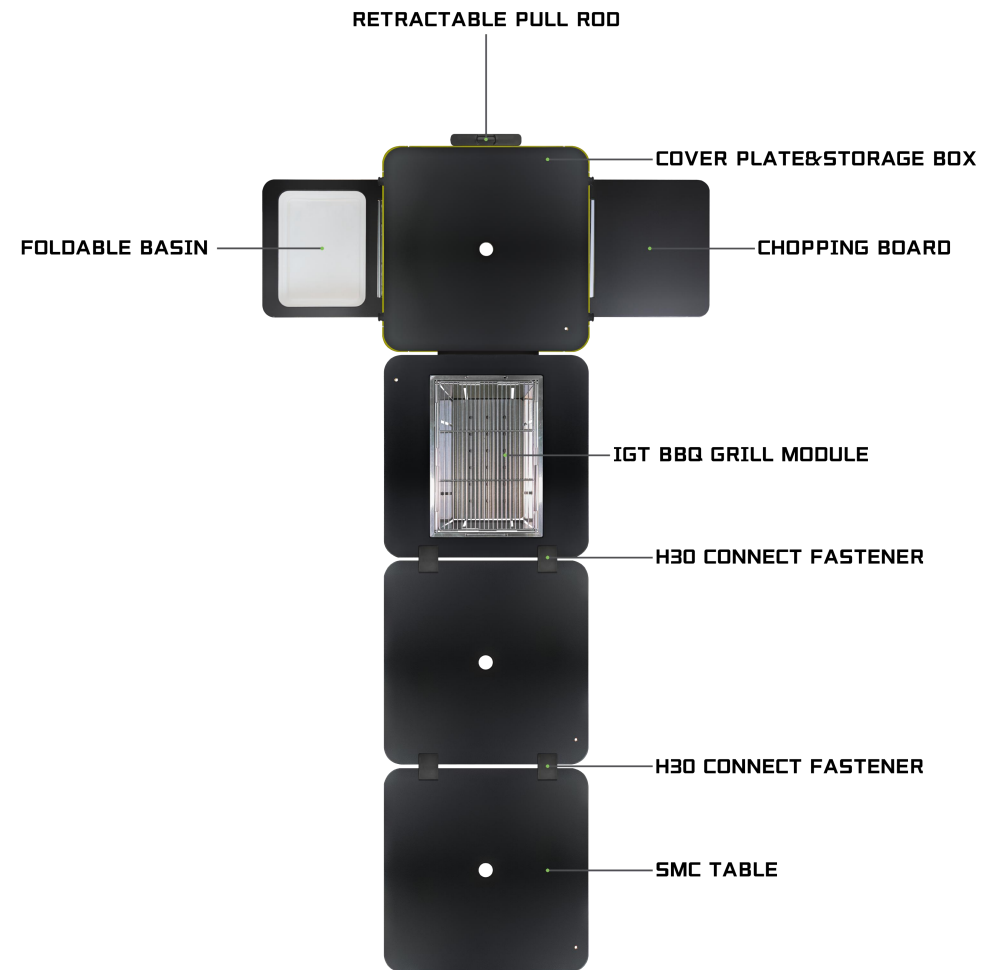
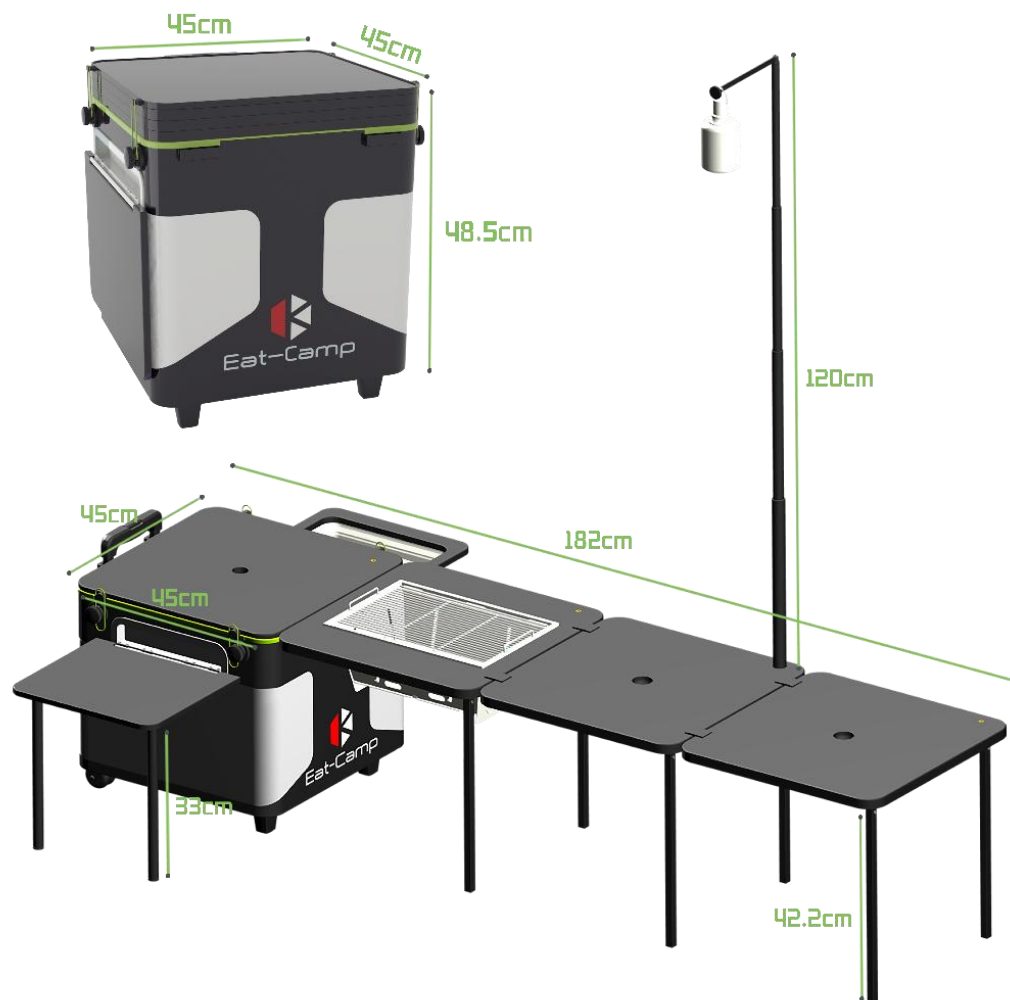

Normal Standard Size: EC 2.0-T TABLE MODEL

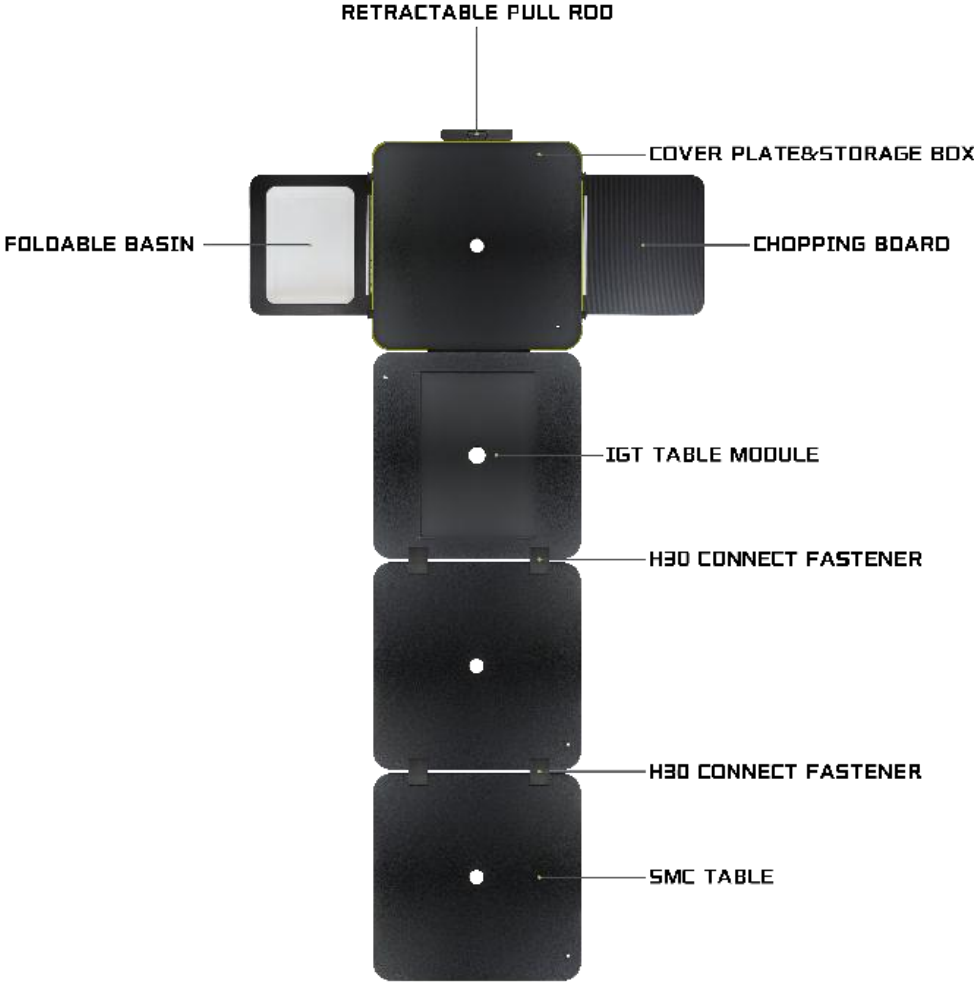
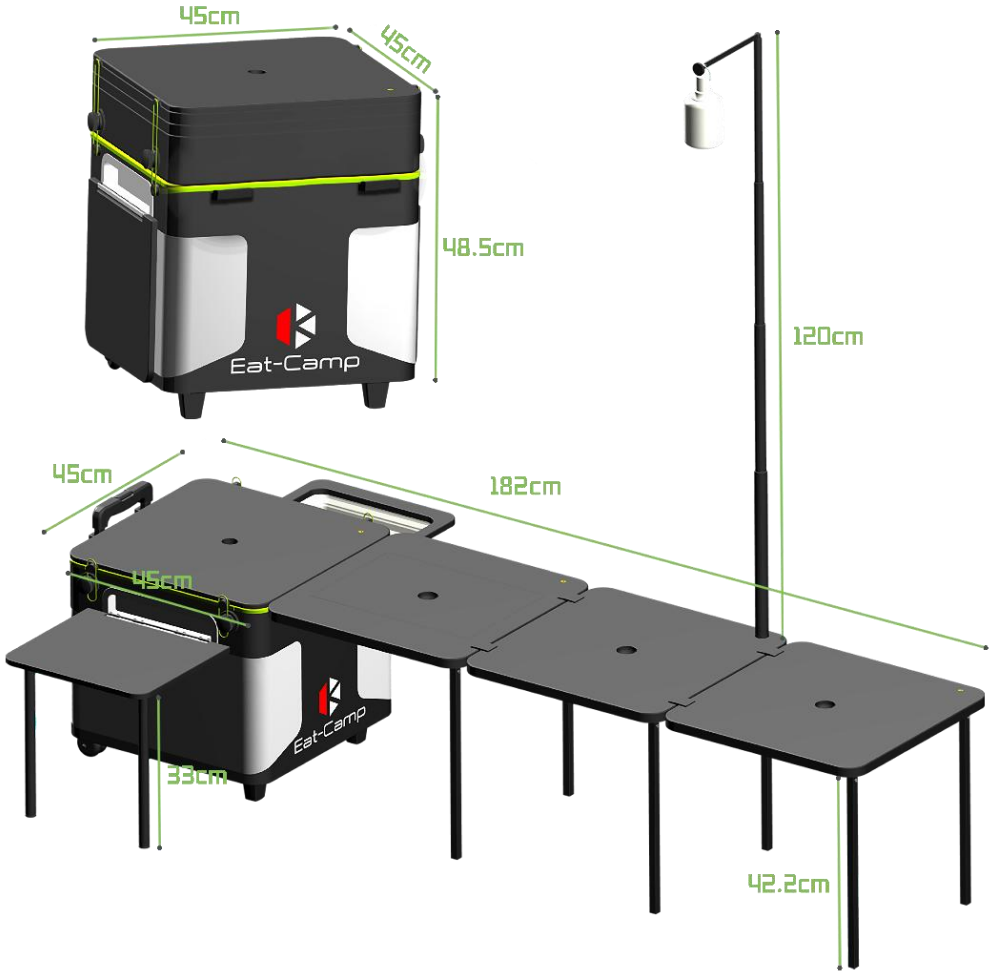

PRODUCT MODELS

Mini Size

01

EC 2.0-ME MODEL

02

EC 2.0-MB MODEL(IGT BBQ GRILL)

03

EC 2.0-MT MODEL



Mini Size: EC 2.0-ME INDUCTION COOKER MODEL

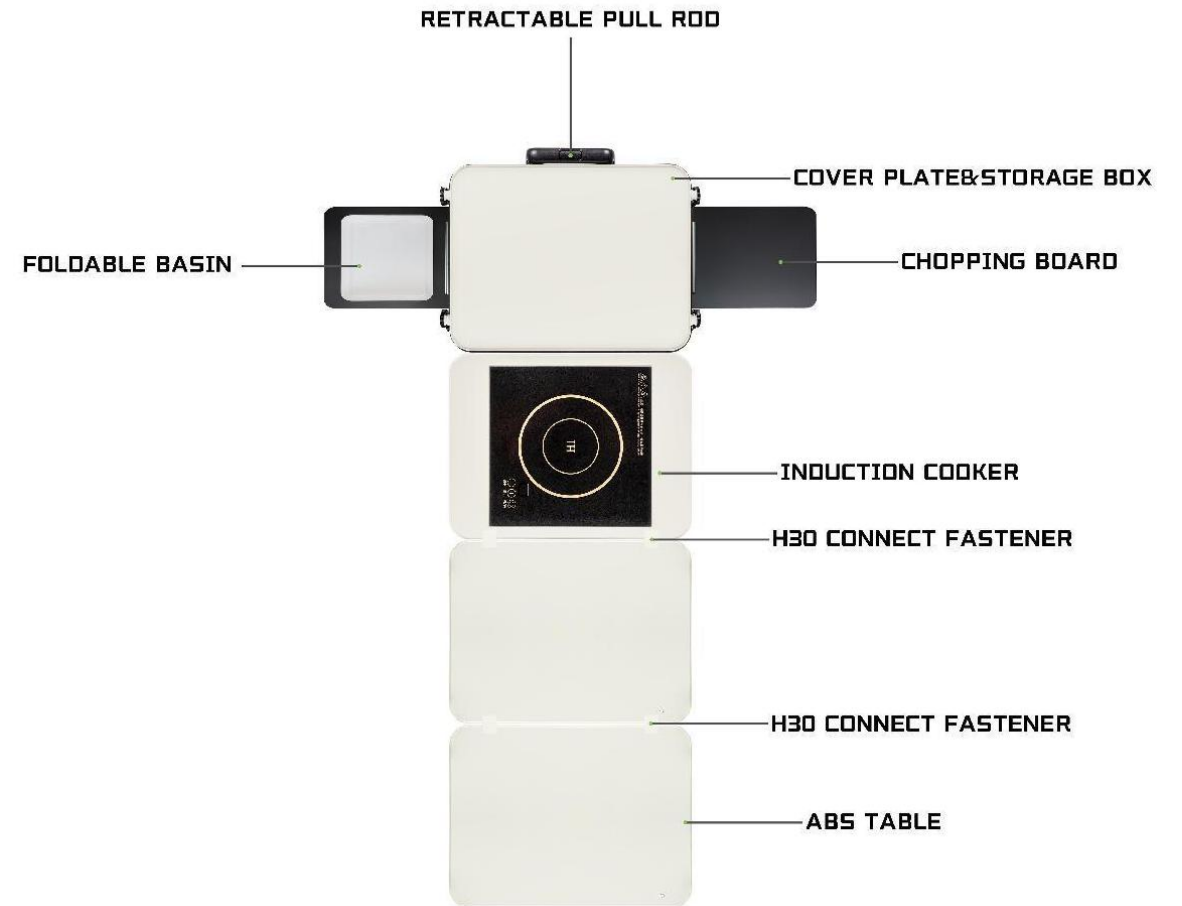

Mini Size: EC 2.0-MB BBQ GRILL MODEL

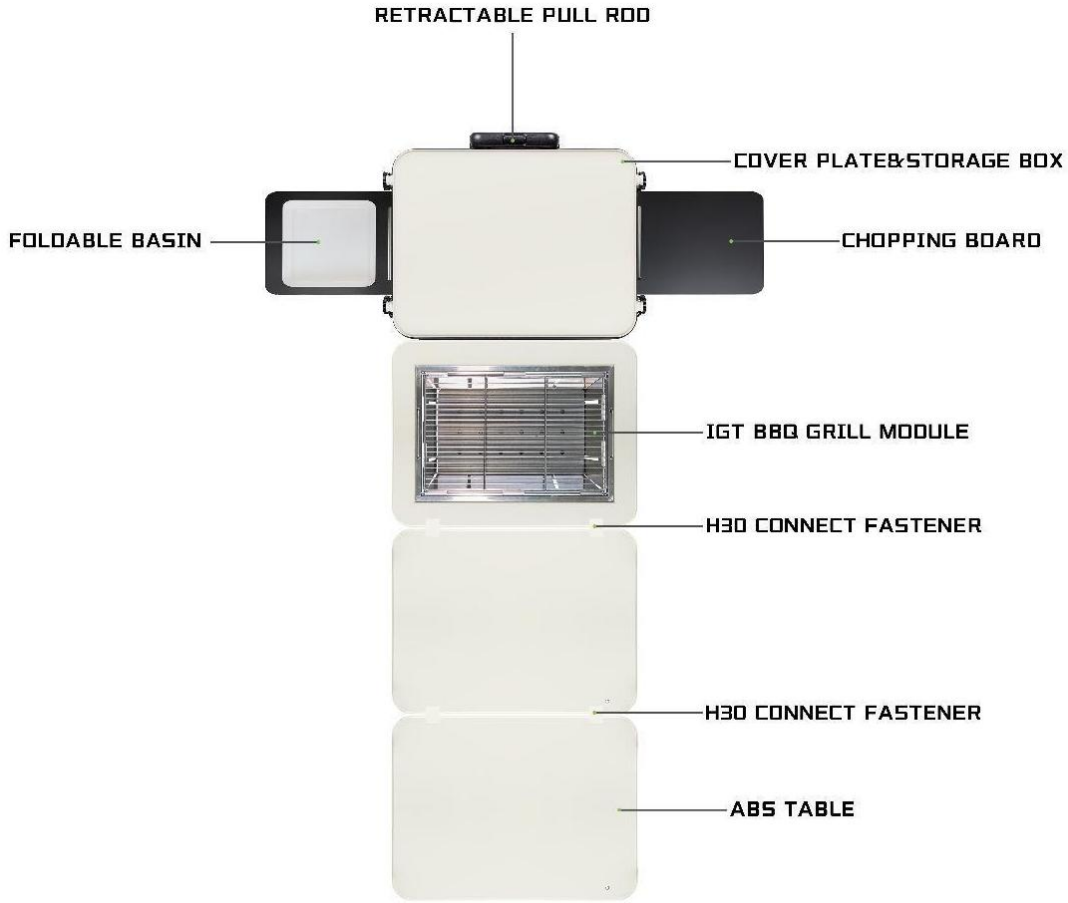

Mini Size: EC 2.0-MT TABLE MODEL

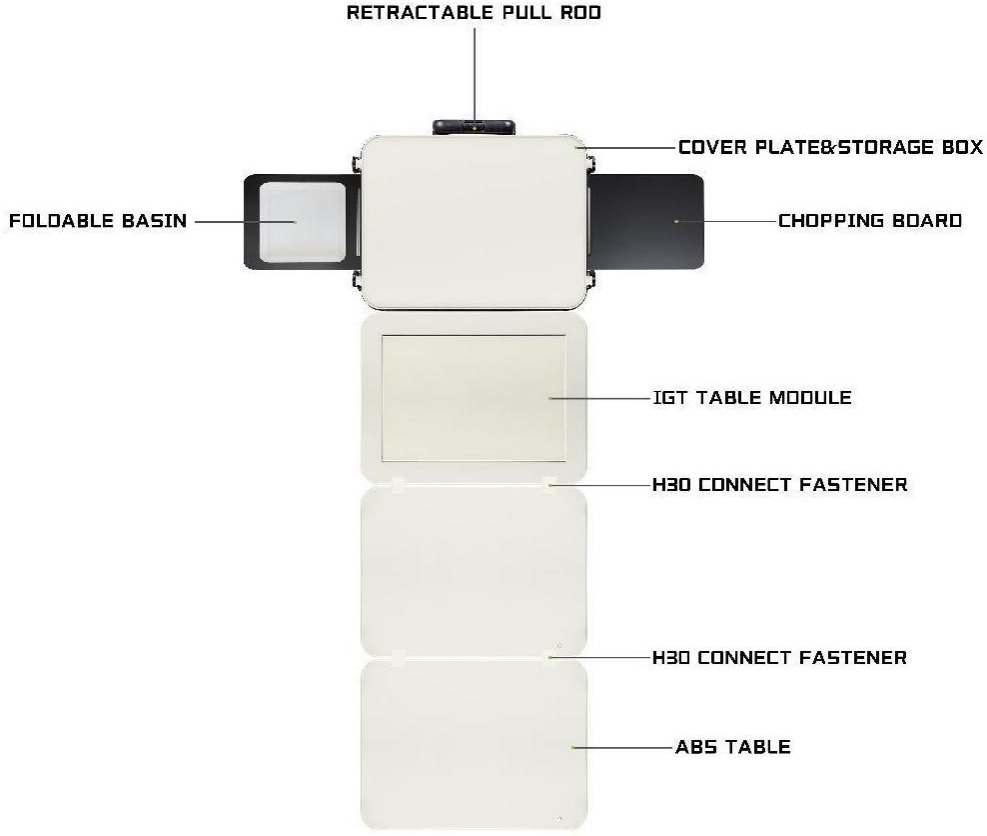

Different Installation for Tables

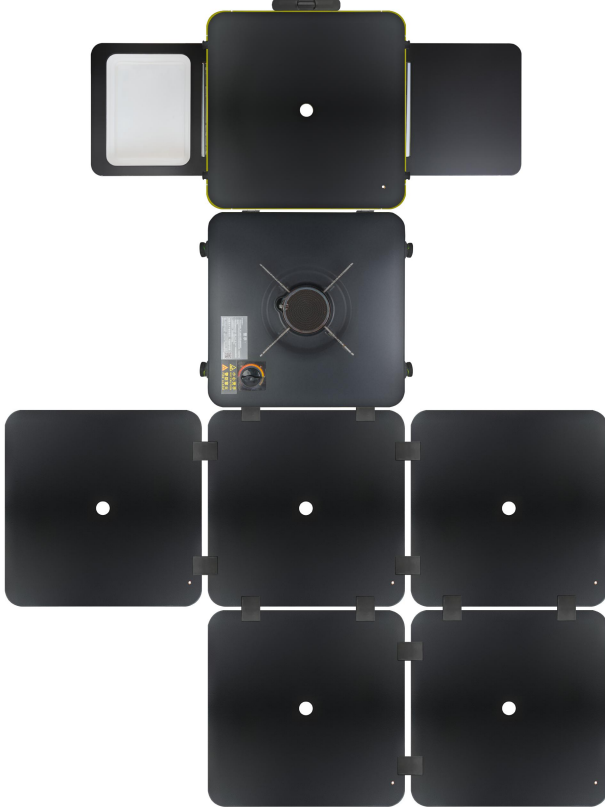
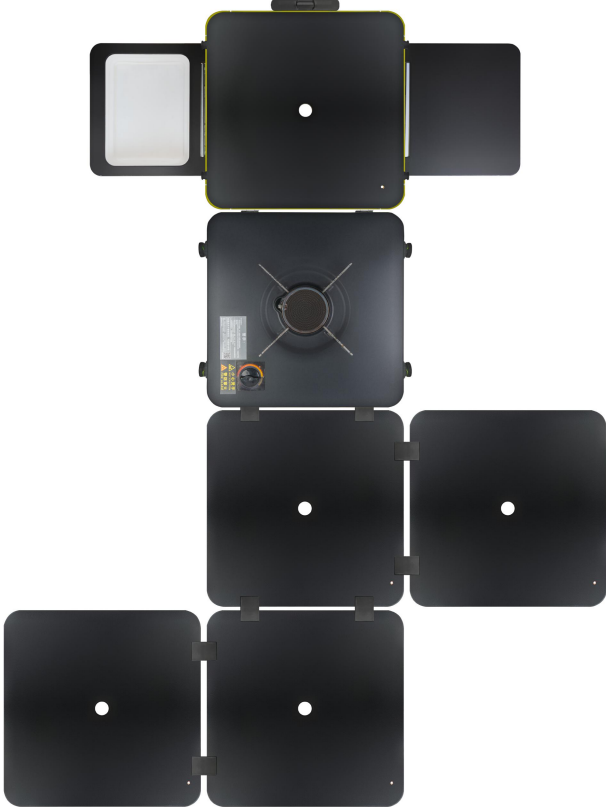
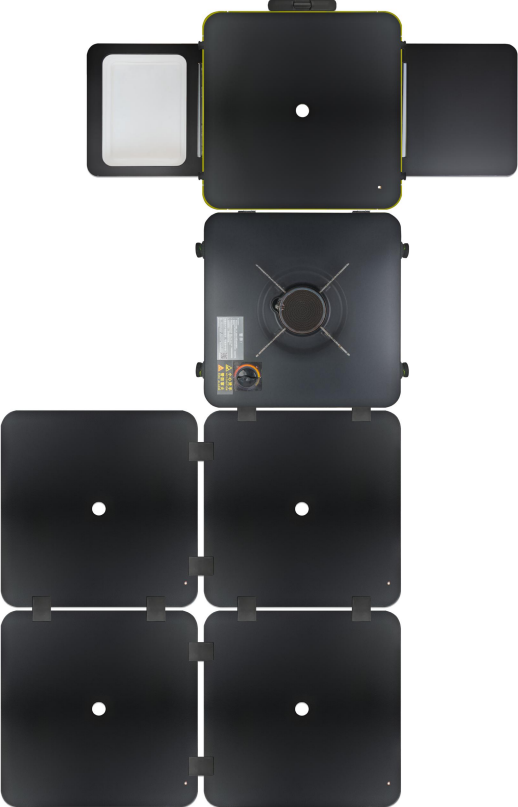

Different Installation for Tables

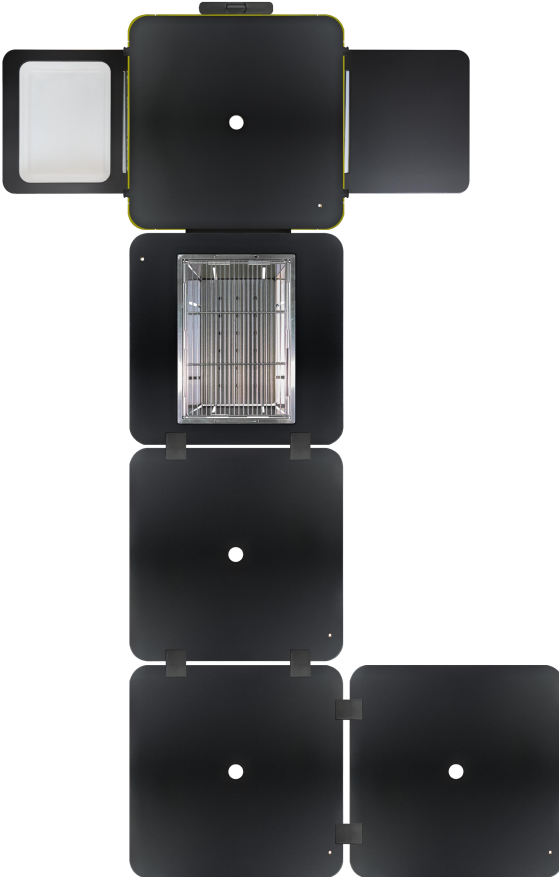
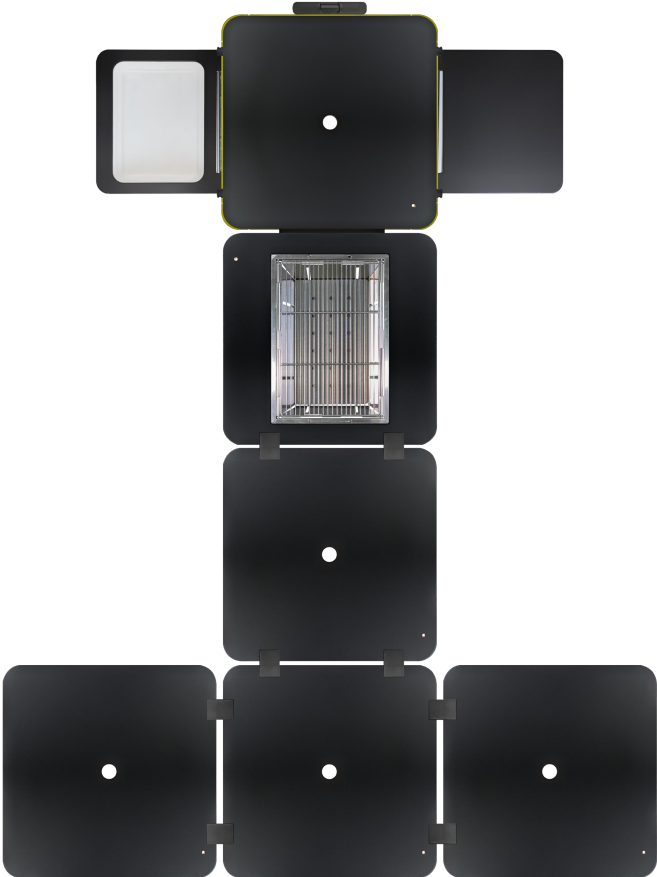
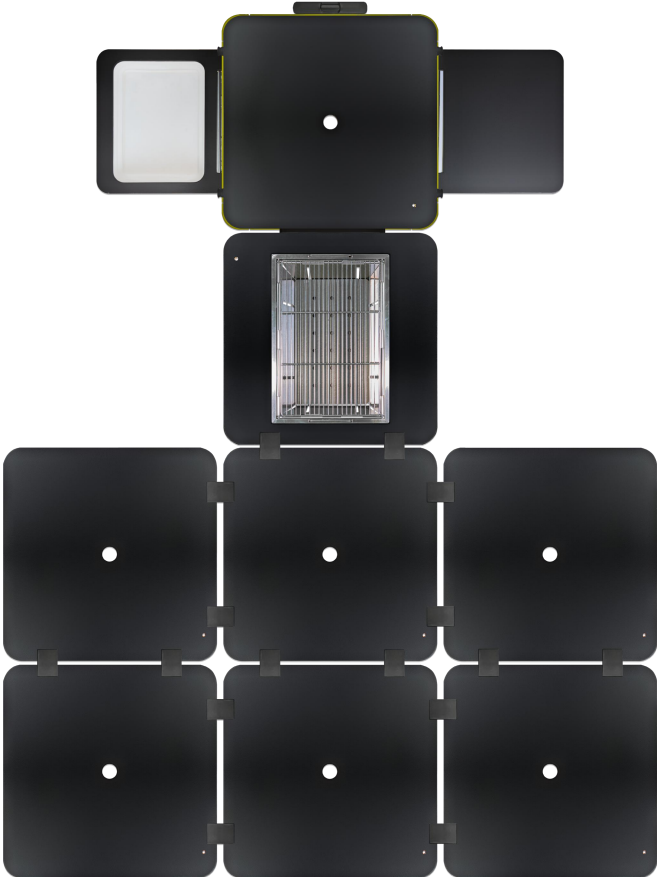

Different Installation for Tables

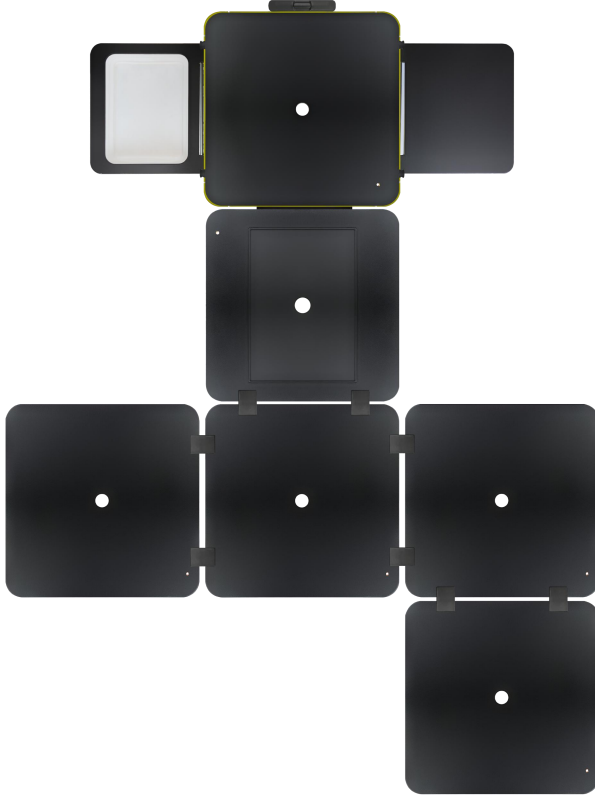
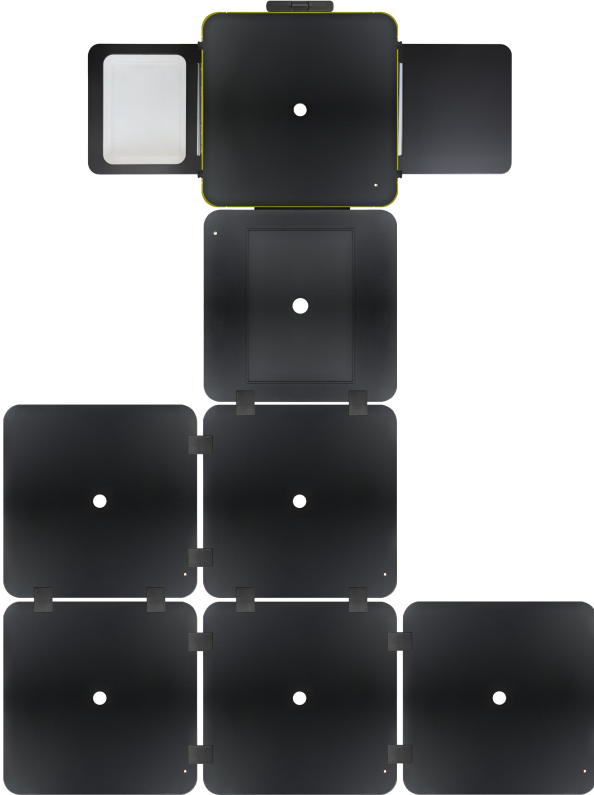
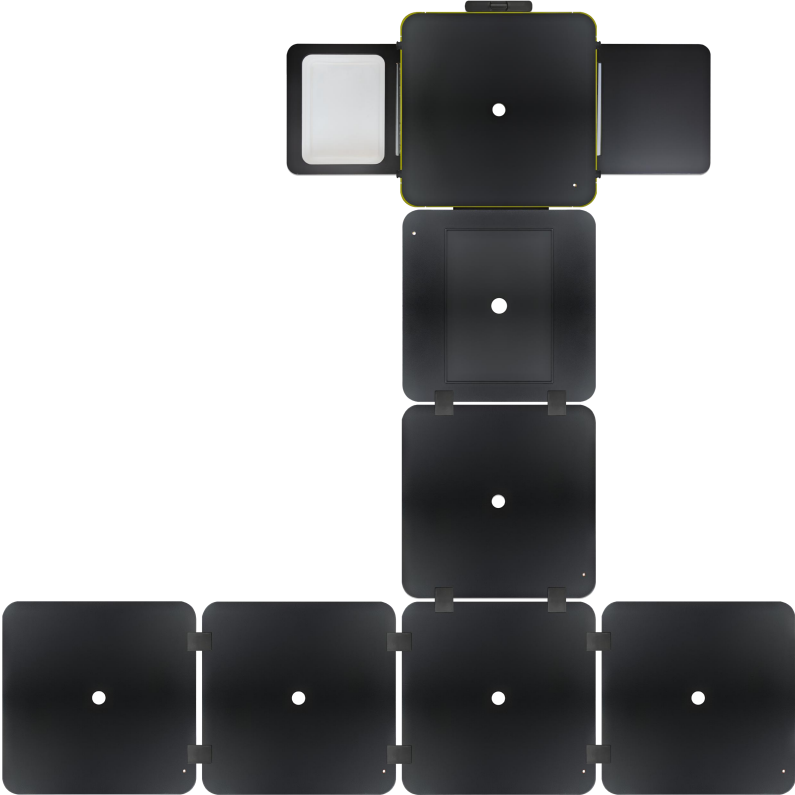

IGT Modular Table

Applicable to BBQ
Grill



Opening

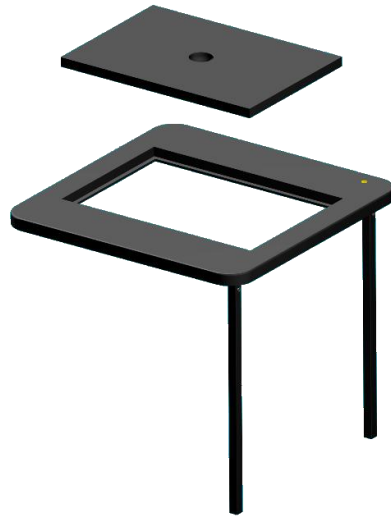

Closing



Folding Status Display

Tables Are Folded On The Top of Storage Box

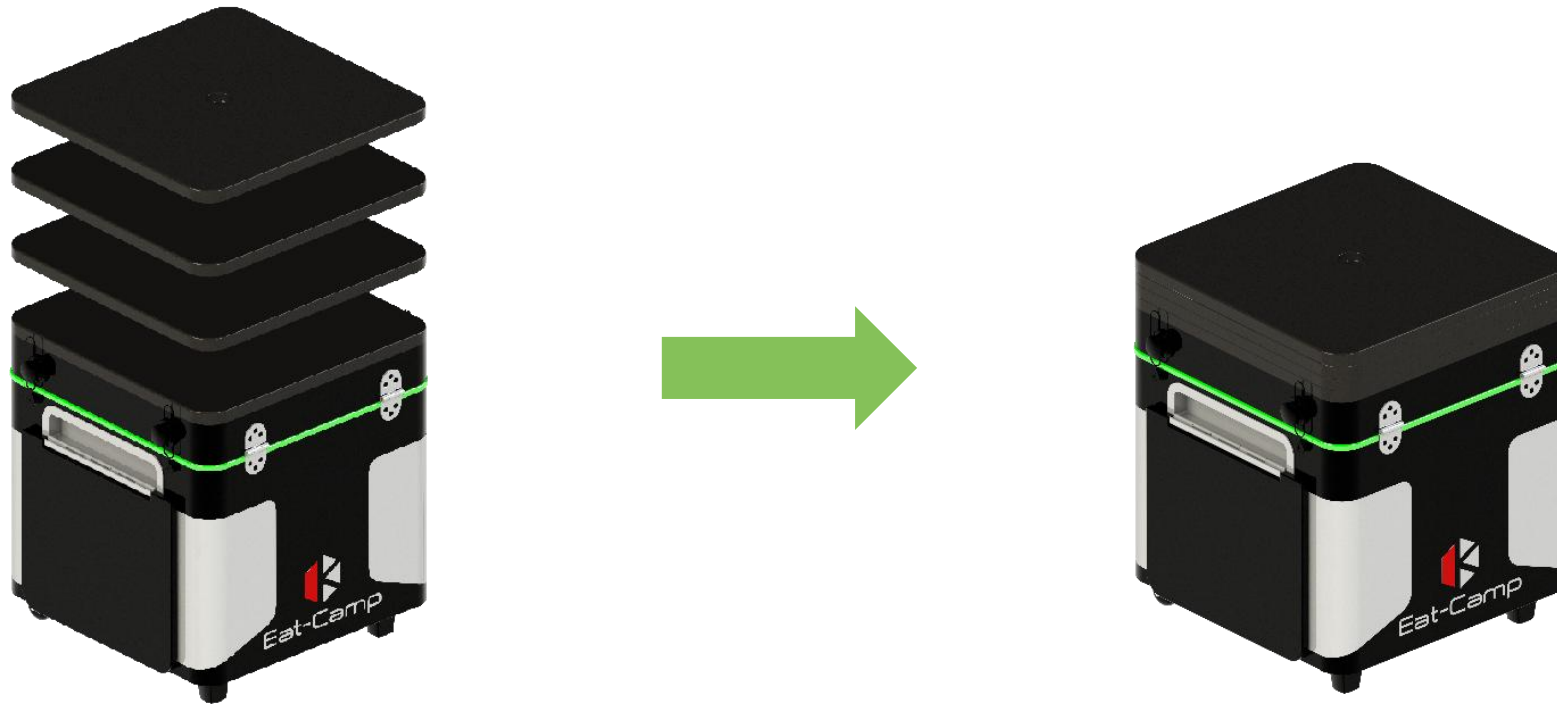

Expansion with Separate Tables(Optional)

Can Be Installed From Different Directions by Using Those Connect Fasteners



Main Components Description

Fasteners for Gas Stove Module
Connected with Other Tables

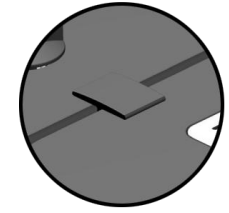
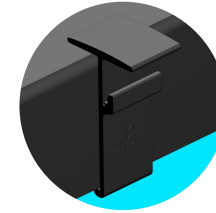

Fasteners for Table Connected
with Table

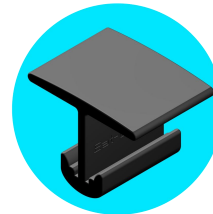

Locking Different Modules

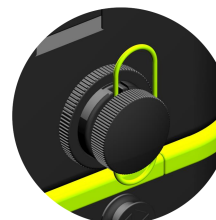
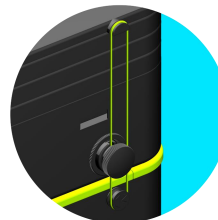

Gas Tank Connection Instructions



applicable to different gas tanks



gas tank is better to be away from the stove



need to use adaptor for this kind of gas tanks



recommend to use this connection tube for safety purpose

Warning! Make Sure the Ignition Switch to Be "OFF" Before You Install Gas Tank

Specs Datas

MODELS	Normal Size				Mini Size		
	EC2.0-T TABLE MODEL	EC2.0-G GAS STOVE MODEL	EC2.0-B BBQ GRILL MODEL	EC2.0-E INDUCTION COOKER MODEL	EC2.0-MT TABLE MODEL	EC2.0-MB BBQ GRILL MODEL	EC2.0-ME INDUCTION COOKER MODEL
Photos							
Folded size (L*W*H)	450*470*485mm	450*470*530mm	450*470*485mm	450*470*530mm	450*350*515mm	450*350*515mm	450*350*520mm
Expansion Size (L*W*H)	1820*1028*422mm	1820*1028*422mm	1820*1028*422mm	1820*1028*422mm	1420*1028*422mm	1420*1028*422mm	1420*1028*520mm
Main Materials	Coated Steel, SMC, Aluminium Alloy etc.	Coated Steel, SMC, Aluminium Alloy etc.	Coated Steel, SMC, Aluminium Alloy etc.	Coated Steel, SMC, Aluminium Alloy etc.	Coated Steel, ABS, Aluminium Alloy etc.	Coated Steel, ABS, Aluminium Alloy etc.	Coated Steel, ABS, Aluminium Alloy etc.
Applicable Fuel	Charcoal or Solid Fuel	Butane, Propane or LPG	Charcoal or Solid Fuel	Electricity	Charcoal or Solid Fuel	Charcoal or Solid Fuel	Electricity
Storage Volume	65 L	65 L	65 L	65 L	55 L	55 L	65 L
Power	N/A	3 KW	N/A	2 KW	N/A	N/A	2 KW
Outer Box Size	53.5*53.5*54cm	53.5*53.5*59cm	53.5*53.5*54cm	53.5*53.5*59cm	53.5*42.5*59cm	53.5*42.5*59cm	53.5*42.5*59cm
Product Net Weight	16 kgs	18.2 kgs	18.3 kgs	19.5 kgs	12.5 kgs	14.7 kgs	14.5 kgs
Packing Quantity	1 Unit/Carton	1 Unit/Carton	1 Unit/Carton	1 Unit/Carton	1 Unit/Carton	1 Unit/Carton	1 Unit/Carton
Gross Weight	18 kgs	21.5 kgs	20.5 kgs	22.5 kgs	14.5 kgs	16.5 kgs	16.5kgs
Container Loading Quantity (Without Pallets)	20'GP: 170 sets or so 40'HQ: 410 sets or so	20'GP: 155 sets or so 40'HQ: 375 sets or so	20'GP: 170 sets or so 40'HQ: 410 sets or so	20'GP: 155 sets or so 40'HQ: 375 sets or so	20'GP: 195 sets or so 40'HQ: 480 sets or so	20'GP: 195 sets or so 40'HQ: 480 sets or so	20'GP: 195 sets or so 40'HQ: 480 sets or so
Product Features	Portable&Moveable; Easy to handle; Multi-functional; Free-Expansion; Big Sroage Volume; All-in-one Design						
Application Scenarios	Outdoor Cooking ,Barbecue, Camping, RV Touring,Wild Expoloration, Soho etc						

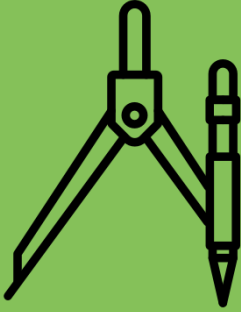

OEM & CUSTOMIZED

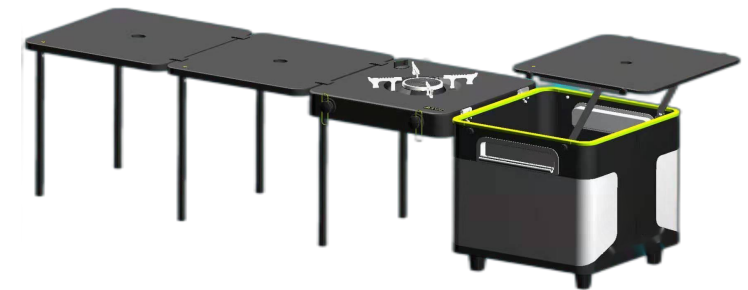

Strategic Cooperation Partners



CAMEL



比亚迪汽车 广汽 HONDA

Scan For Video Guide

Installation



Gas Canister Connection



Thanks

Web: www.intecamp.com

Email: sales@intecamp.com

WhatsApp/Phone: +86 18602595888